



COMMERCIAL
LOOKBOOK

HELLO

AT OUR CORE, We Are Committed to
Serve, Create, And Inspire
Our People And Customers.

We believe in developing spaces which foster collaboration, engagement, and creativity. Soft seating is all we do, and foam is all we do it with.



LOUNGE & CAFÉ



A. F005 ROUND OTTOMAN
B. F136 CONNECT LOW BACK SOFA RIGHT HAND
C. F138 CONNECT LOW BACK TABLE

D. F134 CONNECT LOW BACK CURVED CHAIR
E. F137 CONNECT LOW BACK SOFA LEFT HAND
F. F131 CAFÉ BOOTH

G. PA131 CAFÉ SEPARATOR
H. F009 BENCH 48



LOBBY



A. F108 CURVED BENCH 30
B. F018 CURVED LOVESEAT
C. F020 CURVED SOFA IN

D. F109 CURVED OUTSIDE SOFA 40
E. F005 ROUND OTTOMAN
F. F009 BENCH 48



A. F005 ROUND OTTOMAN
B. F150 LOW ARM CLUB SOCIAL CHAIR
C. F003 CRESCENT OTTOMAN

D. F139 LINEAR REFRESH CHAIR
E. F106 CURVED BENCH 60
F. F009 BENCH 48

SPACES IN BETWEEN





MEET

- A. F001 RECTANGLE OTTOMAN
- B. F029 TWO STEP INSIDE CORNER
- C. F027 TWO STEP
- D. F005 ROUND OTTOMAN
- E. F053 ARMLESS SOCIAL CHAIR
- F. F030 TWO STEP OUTSIDE CORNER
- G. F112 DIAMOND OTTOMAN
- H. F115 TRAPEZOID BENCH
- I. F123 BOOMERANG SOFA





COLLABORATION

- A. F050 CLUB SOCIAL CHAIR
- B. F001 RECTANGLE OTTOMAN
- C. F062 LINEAR WEDGE
- D. F009 BENCH 48
- E. F019 LINEAR SOFA
- F. F024 LINEAR CORNER





OFFICE

- 
- A. F142 LINEAR REFRESH OTTOMAN
B. F139 LINEAR REFRESH CHAIR
C. F141 LINEAR REFRESH SOFA
D. F143 LINEAR REFRESH BENCH
E. F005 ROUND OTTOMAN

IDEA STARTERS

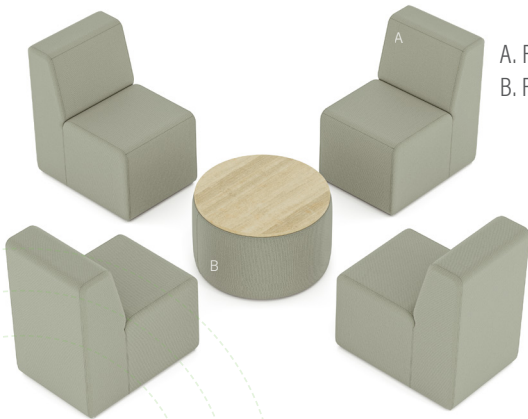

A. F016 LINEAR CHAIR
B. F005-30 ROUND OTTOMAN



A. F005-30 ROUND OTTOMAN
B. F019 LINEAR SOFA
C. F061 CURVED CORNER
D. F016 LINEAR CHAIR
E. F062 LINEAR WEDGE

A. F131 CAFÉ BOOTH
B. PA131 CAFÉ SEPARATOR

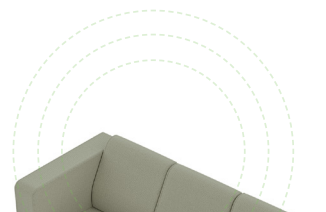

A. F139 LINEAR REFRESH CHAIR
B. F001 RECTANGLE OTTOMAN
C. F141 LINEAR REFRESH SOFA



A. F050 CLUB SOCIAL CHAIR
B. F001 RECTANGLE OTTOMAN
C. F052 RIGHT SOCIAL CHAIR
D. F053 ARMLESS SOCIAL CHAIR
E. F051 LEFT SOCIAL CHAIR

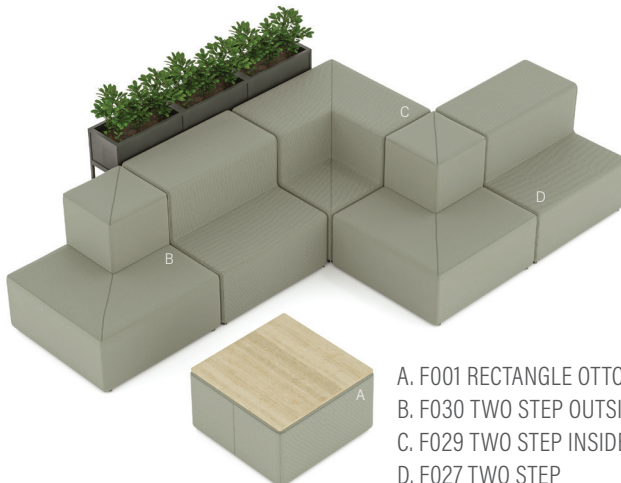

A. F001 RECTANGLE OTTOMAN
B. F030 TWO STEP OUTSIDE CORNER
C. F029 TWO STEP INSIDE CORNER
D. F027 TWO STEP

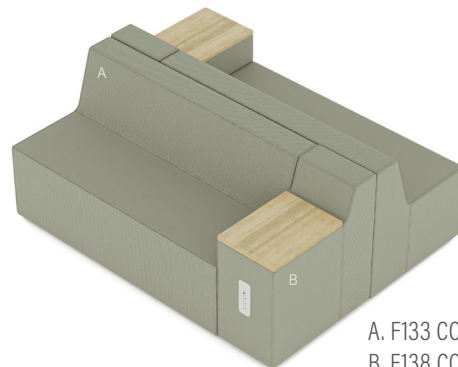

A. F133 CONNECT LOW BACK SOFA
B. F138 CONNECT LOW BACK TABLE

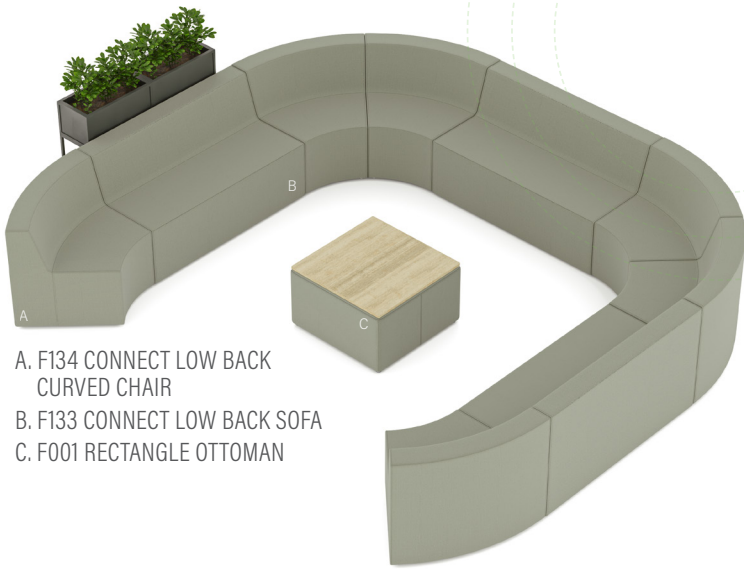

A. F134 CONNECT LOW BACK CURVED CHAIR
 B. F133 CONNECT LOW BACK SOFA
 C. F001 RECTANGLE OTTOMAN

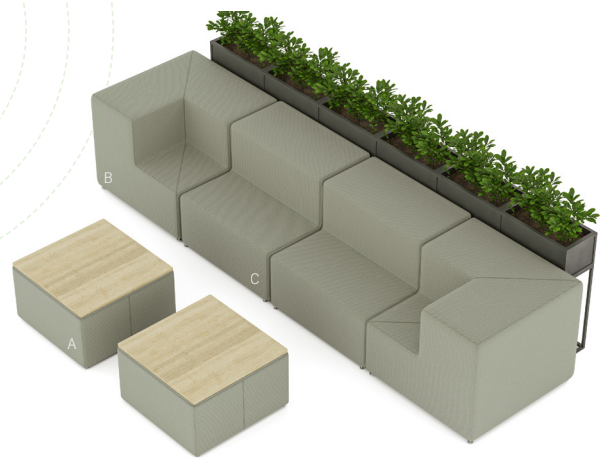

A. F001 RECTANGLE OTTOMAN
 B. F029 TWO STEP INSIDE CORNER
 C. F027 TWO STEP

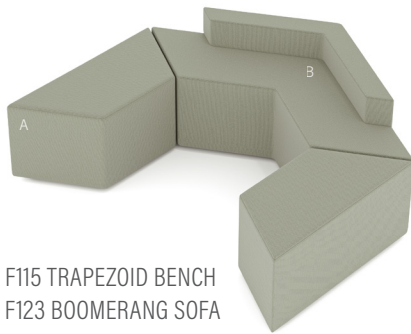

A. F115 TRAPEZOID BENCH
 B. F123 BOOMERANG SOFA

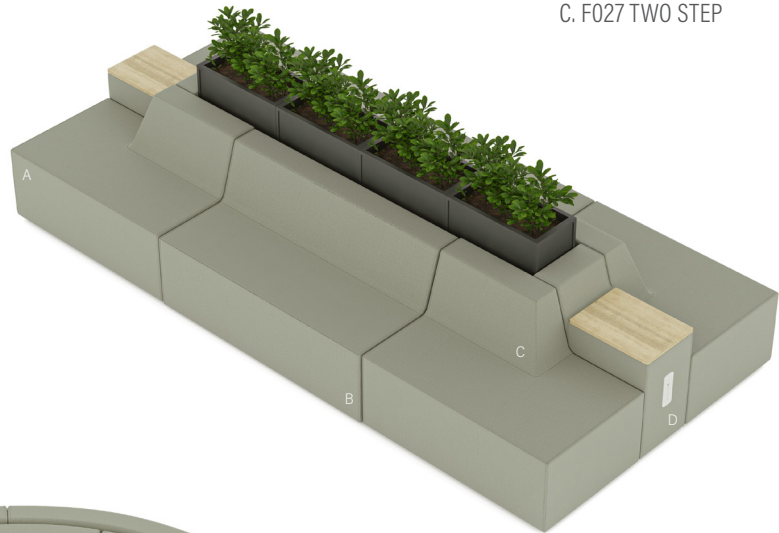

A. F136 CONNECT LOW BACK SOFA RIGHT HAND
 B. F133 CONNECT LOW BACK SOFA
 C. F137 CONNECT LOW BACK SOFA LEFT HAND
 D. F138 CONNECT LOW BACK TABLE

A. F109 CURVED OUTSIDE SOFA 40
 B. F020 CURVED SOFA IN
 C. F005-18 ROUND OTTOMAN

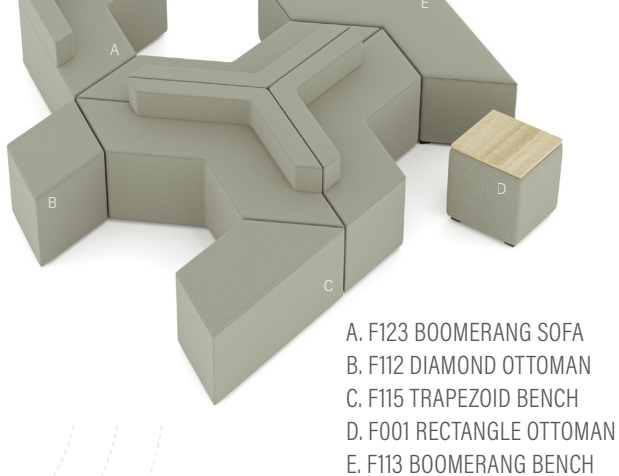

A. F123 BOOMERANG SOFA
 B. F112 DIAMOND OTTOMAN
 C. F115 TRAPEZOID BENCH
 D. F001 RECTANGLE OTTOMAN
 E. F113 BOOMERANG BENCH

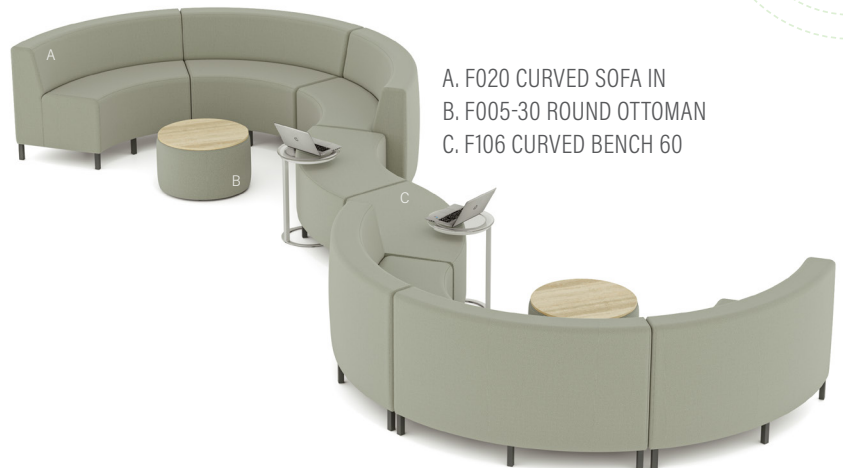

A. F020 CURVED SOFA IN
 B. F005-30 ROUND OTTOMAN
 C. F106 CURVED BENCH 60

CUSTOM SHAPES

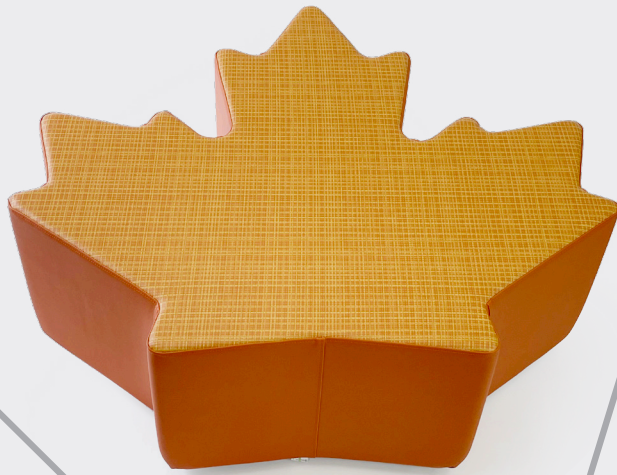

SOFT EDGE VS. HARD EDGE

SOLID FOAM VS. WOOD FRAME

LIGHT VS. HEAVY

WHY FOAM?



FÖM CORE



NOT-SO "SOFT SEATING"



QUALITY FOAM & DENSITY

NO PINCH POINTS

LIFETIME WARRANTY



MODIFICATIONS

- Seat height
- Textile and placement
- Leg, caster, and foot options
- Fully zippered (no wood base)
- Colored stitching and zipper
- TFL worksurface
- Embroidery
- Weather resistant
- Power

LEG OPTIONS



1" Nylon Glide (G1)



1" Felt Glide (G1)

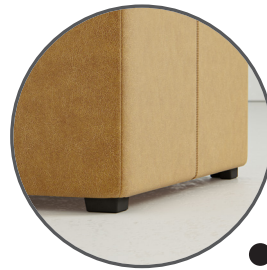

1" Low Profile Leg (L1)



3" Rectangle Leg (R3)



3" Caster (C3)



6" Caster (C6)



6" Mod Leg (M6)



6" Rectangle Leg (R6)



6" Triangle Leg (T6)



6" Sled Leg (S16, S29)



A. F020 CURVED SOFA IN
 B. F005 ROUND OTTOMAN
 C. F001 RECTANGLE OTTOMAN



CUSTOMER SERVICE

INFORMATION & MORE

PURCHASE ORDERS

Be sure to include:

1. Quantity
2. SKU Number
3. Description
4. Pattern name and color choice
5. Color guide for items requiring one
6. Price for each item

Fōmcore accepts orders via:

- Email: sales@fomcore.com
- Contact your regional sales director

Modification of orders must be submitted to Fōmcore in writing within 48 hours of initial sales order acknowledgment. In some cases, a change order fee may be charged if work is in progress or custom products are involved.

TERMS

Invoice terms for credit accounts are Net 30 days. Orders are invoiced on day of shipment. New customers and international customers are cash in advance.

SHIPPING - LEAD TIMES

All furniture is made to order. Shipping date is confirmed upon receipt of order. Every attempt will be made to meet that shipping date, however, it is subject to change without prior notification. Fōmcore reserves the right to discontinue products and change product specifications and prices. Fōmcore delivers to all 48 contiguous states. All orders delivering to other states and international locations are FOB Muskegon (zip code 49442), Michigan.

WARRANTY

Products manufactured by Fōmcore are warranted to be free of defects in material and workmanship under normal use for the lifetime of the product, unless otherwise noted. Product must be properly cared for, maintained, and in use by its original owner. Under the warranty, the obligation of Fōmcore is limited to the repair or replacement of such furniture. Damage in transit or by negligence, abuse, abnormal usage, misuse, accidents, or alterations nullifies the warranty. As Buyer's sole remedy under this warranty, Fōmcore, at its option, will repair or replace damaged parts at no charge to the original owner of record provided the replacement or return has previously been authorized by Fōmcore under terms of this warranty. Normal aging and wear of fabrics, filling materials, and finishes are expected from this warranty. It is expressly agreed that this remedy of repair, replacement, or credit, at Fōmcore's option, is Buyer's exclusive remedy under this warranty. In no event shall Seller be liable for consequential damages.

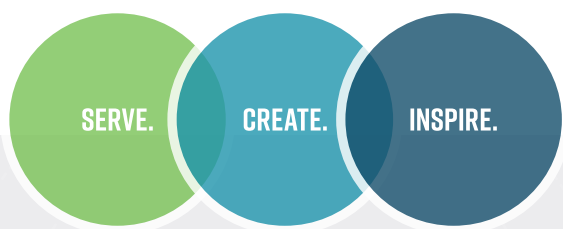

OUR COMMITMENT TO THE ENVIRONMENT AND SUSTAINABILITY

As the foam experts, our unique foam life cycle represents our continued commitment to the care and health of our environment and customers.

Our shop begins with selecting high quality materials to produce your customizable pieces. One of our steps in eliminating ALL waste is efficiently cutting into the foam bun the shapes and sizes. The excess from

GET IN TOUCH

REGIONAL DIRECTORS



Dave Diller

REGIONAL DIRECTOR - WEST

PHONE: 231.366.4791 x319

DIRECT: 231.246.1536

EMAIL: dave@fomcore.com



Mark Gardner

REGIONAL DIRECTOR - MIDWEST/CANADA

PHONE: 231.366.4791 x321

DIRECT: 231.246.4564

EMAIL: mark@fomcore.com

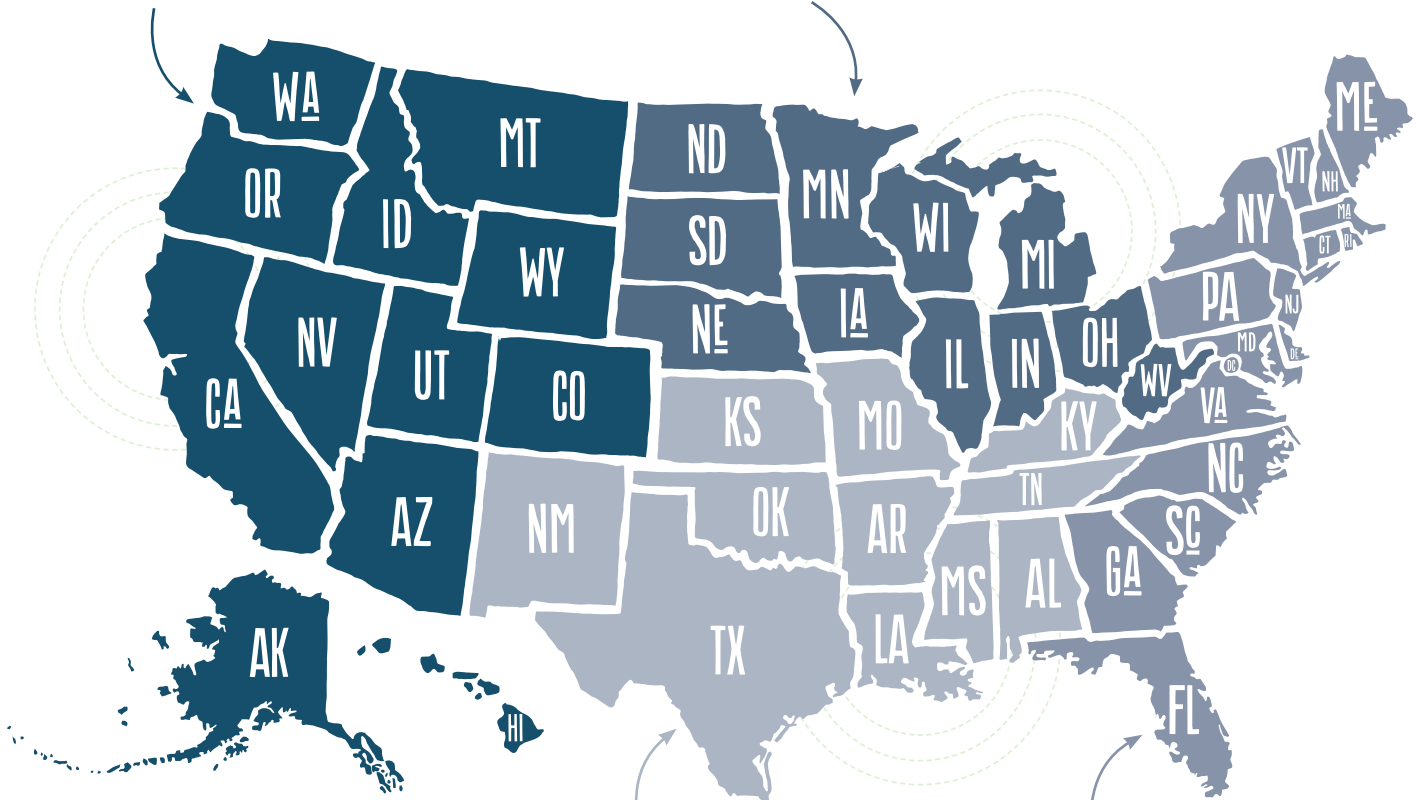

Lance Wild

REGIONAL DIRECTOR - SOUTH

PHONE: 231.366.4791 x320

DIRECT: 231.246.4563

EMAIL: lance@fomcore.com



Caleb Sibert

REGIONAL DIRECTOR - EAST

PHONE: 231.366.4791 x322

DIRECT: 231.246.4566

EMAIL: caleb@fomcore.com

Fomcore

1770 E. Keating Ave Muskegon, MI 49442

Tel: 231.366.4791 • www.fomcore.com

our Amoebas, Rounds, and Lily Pads, for example, is shredded and recycled for products such as carpet padding and insulation.

An additional way we care about you and our environment includes exceeding the expectations and standards in the furniture industry. We earned the Clean Air Gold Certification for our foam and fabric. This means our products have been independently tested by industry leaders for emissions into the ambient air. What does this mean for you? You can breathe easy in your workplace.



WANT TO SEE MORE PRODUCTS?

VIEW OUR FULL LINE CATALOG »

A. F005 ROUND OTTOMAN
B. F019 LINEAR SOFA
C. F024 LINEAR CORNER
D. F017 LINEAR LOVESEAT
E. F107 LINEAR OTTOMAN



Fōmcore
SERVE. CREATE. INSPIRE.

1770 E. Keating Ave - Muskegon, MI 49442 • Tel: 231.366.4791 • www.fomcore.com